



Bullet shape die cast aluminum flood with spotlighting for over 40 feet away. 13 Watt LED High Performance Light Engine.

Color: Bronze

Weight: 3.5 lbs

Project:	Type:
Prepared By:	Date:

Driver Info		LED Info	
Type:	Constant Current	Watts:	13W
120V:	0.12A	Color Temp:	4000K
208V:	0.09A	Color Accuracy:	84 CRI
240V:	0.08A	L70 Lifespan:	100000
277V:	0.07A	Lumens:	1111
Input Watts:	15W	Efficacy:	77 LPW
Efficiency:	90%		

Technical Specifications

Listings

UL Listing:

Suitable for wet locations. Suitable for ground mounting.

IESNA LM-79 & IESNA LM-80 Testing:

RAB LED luminaires have been tested by an independent laboratory in accordance with IESNA LM-79 and 80, and have received the Department of Energy "Lighting Facts" label.

LED Characteristics

Lifespan:

100,000-hour LED lifespan based on IES LM-80 results and TM-21 calculations.

LEDs:

13 Watt high output, long-life LED.

Lumen Maintenance:

100,000 hours Life Based on LM-80 Tests.

Color Consistency:

3-step MacAdam Ellipse binning to achieve consistent fixture-to-fixture color.

Color Stability:

LED color temperature is warrantied to shift no more than 200K in CCT over a 5 year period.

Color Uniformity:

RAB's range of CCT (Correlated Color Temperature) follows the guidelines of the American National Standard for (SSL) Products, ANSI C78.377-2017.

Optical

Spotlight Distribution:

Beam Angle of 11° and Field Angle of 24° enables the HSLED to produce a very narrow spot distribution.

NEMA Type:

NEMA Beam Spread of 2H x 2V

Electrical

Driver:

Constant Current, Class 2, 100-277V, 50-60Hz, 100-240VAC 0.3-0.15A, 277VAC 0.15A.

Surge Protection:

4kV

Construction

Ambient Temperature:

Suitable For use in 40°C (104°F) ambient temperatures.

Cold Weather Starting:

Minimum starting temperature is -40°C (-40°F)

Thermal Management:

Cast aluminum Thermal Management system for optimal heat sinking. The HSLED is designed for cool operation, most efficient output and maximum LED life by minimizing LED junction temperature.

Housing:

Precision die-cast aluminum housing, hood and mounting arm.

Gaskets:

High Temperature Silicone.

Finish:

Formulated for high-durability and long lasting color.

Green Technology:

Mercury and UV free. RoHS compliant components. Polyester powder coat finish formulated without the use of VOC or toxic heavy metals.

Other

Warranty:

RAB warrants that our LED products will be free from defects in materials and workmanship for a period of five (5) years from the date of delivery to the end user, including coverage of light output, color stability, driver performance and fixture finish.

Patents:

The design of the HSLED is protected by Taiwan Patent 01510965 and patents pending in US, Canada, China, and Mexico.

FTC Country of Origin:

This product was assembled in the USA by RAB using imported components.

Buy American Act Compliance:

This product complies with the Buy American Act.

Dimensions

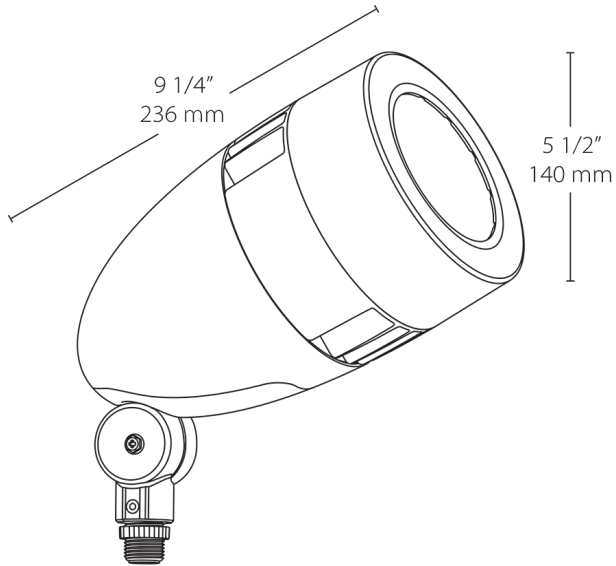

Features

- Spot lighting for over 40 feet away
- Perfect for flag lighting
- NEMA type - 2H x 2V
- Available in four colors
- 100,000-hour life based on LM-80 tests
- 5- year LED warranty